

INSTRUCTION MANUAL

# Thicknesser

2012NB

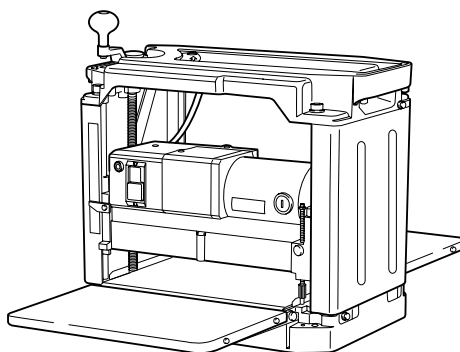

004461

 DOUBLE INSULATION

**IMPORTANT:** Read Before Using.

## ENGLISH (Original instructions)

# SPECIFICATIONS

Model	2012NB
Cutting width	304 mm
Max. cutting depth	3.0 mm of stock width less than 150 mm 1.5 mm of stock width from 150 mm to 240 mm 1.0 mm of stock width from 240 mm to 304 mm
Feed rate (min <sup>-1</sup> )	8.5 m
Table size (W x L)	304 mm x 771 mm
No load speed (min <sup>-1</sup> )	8,500
Overall length (W x L x H)	483 mm x 771 mm x 401 mm
Net weight	28.1 kg
safety class	□/II

- Due to our continuing programme of research and development, the specifications herein are subject to change without notice.
- Specifications may differ from country to country.
- Weight according to EPTA-Procedure 01/2003

END201-5

## Symbols

The following show the symbols used for the equipment. Be sure that you understand their meaning before use.



- Read instruction manual.



- DOUBLE INSULATION



- Only for EU countries  
Do not dispose of electric equipment together with household waste material! In observance of European Directive 2002/96/EC on waste electric and electronic equipment and its implementation in accordance with national law, electric equipment that have reached the end of their life must be collected separately and returned to an environmentally compatible recycling facility.

ENE001-1

## Intended use

The tool is intended for planing wood.

ENF002-1

## Power supply

The tool should be connected only to a power supply of the same voltage as indicated on the nameplate, and can only be operated on single-phase AC supply. They are double-insulated in accordance with European Standard and can, therefore, also be used from sockets without earth wire.

ENF100-1

## For public low-voltage distribution systems of between 220 V and 250 V.

Switching operations of electric apparatus cause voltage fluctuations. The operation of this device under

unfavorable mains conditions can have adverse effects to the operation of other equipment. With a mains impedance equal or less than 0.38 Ohms it can be presumed that there will be no negative effects. The mains socket used for this device must be protected with a fuse or protective circuit breaker having slow tripping characteristics.

ENG905-1

## Noise

The typical A-weighted noise level determined according to EN61029:

Sound pressure level ( $L_{pA}$ ) : 86 dB(A)  
Sound power level ( $L_{WA}$ ) : 99 dB(A)  
Uncertainty (K) : 3 dB(A)

## Wear ear protection

ENH037-1

## For European countries only

### EC Declaration of Conformity

**We Makita Corporation as the responsible manufacturer declare that the following Makita machine(s):**

Designation of Machine:

Thicknesser

Model No./ Type: 2012NB

are of series production and

**Conforms to the following European Directives:**

2006/42/EC

And are manufactured in accordance with the following standard or standardized documents:

EN12100-1, IEC61029, EN860

The EC Type-Examination Certificate No. 10-SKM-CM-0523

The EC Type-Examination per 2006/42/EC was performed by:

Inspecta Sweden AB  
PO Box 30100  
SE-104 25 STOCKHOLM, Sweden  
Identification No. 0409

The technical documentation is kept by our authorized representative in Europe who is:

Makita International Europe Ltd,  
Michigan, Drive, Tongwell,  
Milton Keynes, MK15 8JD, England  
3.3.2010



000230

Tomoyasu Kato  
Director  
Makita Corporation  
3-11-8, Sumiyoshi-cho,  
Anjo, Aichi, JAPAN

ENA001-2

## SAFETY INSTRUCTIONS

**WARNING! When using electric tools, basic safety precautions, including the following, should always be followed to reduce the risk of fire, electric shock and personal injury. Read all these instructions before operating this product and save these instructions.**

### For safe operations:

- 1. Keep work area clean.**  
Cluttered areas and benches invite injuries.
- 2. Consider work area environment.**  
Do not expose power tools to rain. Do not use power tools in damp or wet locations. Keep work area well lit. Do not use power tools where there is risk to cause fire or explosion.
- 3. Guard against electric shock.**  
Avoid body contact with earthed or grounded surfaces (e.g. pipes, radiators, ranges, refrigerators).
- 4. Keep children away.**  
Do not let visitors touch the tool or extension cord. All visitors should be kept away from work area.
- 5. Store idle tools.**  
When not in use, tools should be stored in a dry, high or locked up place, out of reach of children.
- 6. Do not force the tool.**  
It will do the job better and safer at the rate for which it was intended.
- 7. Use the right tool.**  
Do not force small tools or attachments to do the job of a heavy duty tool. Do not use tools for purposes not intended; for example, do not use circular saws to cut tree limbs or logs.
- 8. Dress properly.**  
Do not wear loose clothing or jewellery, they can be caught in moving parts. Rubber gloves and non-skid footwear are recommended when working outdoors. Wear protecting hair covering to contain long hair.
- 9. Use safety glasses and hearing protection.**  
Also use face or dust mask if the cutting operation is dusty.
- 10. Connect dust extraction equipment.**  
If devices are provided for the connection of dust extraction and collection facilities ensure these are connected and properly used.
- 11. Do not abuse the cord.**  
Never carry the tool by the cord or yank it to disconnect it from the socket. Keep the cord away from heat, oil and sharp edges.
- 12. Secure work.**  
Use clamps or a vice to hold the work. It is safer than using your hand and it frees both hands to operate the tool.
- 13. Do not overreach.**  
Keep proper footing and balance at all times.
- 14. Maintain tools with care.**  
Keep cutting tools sharp and clean for better and safer performance. Follow instructions for lubrication and changing accessories. Inspect tool cord periodically and if damaged have it repaired by an authorized service facility. Inspect extension cords periodically and replace, if damaged. Keep handles dry, clean and free from oil and grease.
- 15. Disconnect tools.**  
When not in use, before servicing and when changing accessories such as blades, bits and cutters.
- 16. Remove adjusting keys and wrenches.**  
Form the habit of checking to see that keys and adjusting wrenches are removed from the tool before turning it on.
- 17. Avoid unintentional starting.**  
Do not carry a plugged-in tool with a finger on the switch. Ensure switch is off when plugging in.
- 18. Use outdoor extension leads.**  
When tool is used outdoors, use only extension cords intended for outdoor use.
- 19. Stay alert.**  
Watch what you are doing. Use common sense. Do not operate tool when you are tired.
- 20. Check damaged parts.**  
Before further use of the tool, a guard or other part that is damaged should be carefully checked to determine that it will operate properly and perform its intended function. Check for alignment of moving parts, free running of moving parts,

breakage of parts, mounting and any other conditions that may affect its operation. A guard or other part that is damaged should be properly repaired or replaced by an authorized service center unless otherwise indicated in this instruction manual. Have defective switches replaced by an authorized service facility. Do not use the tool if the switch does not turn it on and off.

21. **Warning.**

The use of any accessory or attachment, other than those recommended in this instruction manual or the catalog, may present a risk of personal injury.

22. **Have your tool repaired by a qualified person.**

This electric tool is in accordance with the relevant safety requirements. Repairs should only be carried out by qualified persons using original spare parts, otherwise this may result in considerable danger to the user.

GEB066-1

## THICKNESSER SAFETY WARNINGS

1. **Wear eye protection.**
2. **Wear suitable personal protective equipment when necessary, such as hearing protection (ear plugs), respiratory protection (dust mask) and gloves when handling rough material.**
3. **Do not use the tool in the presence of flammable liquids or gases.**
4. **Make sure that all covers are installed in place before operation.**
5. **Handle the blades very carefully.**
6. **Check the blades carefully for cracks or damage before operation. Replace cracked or damaged blades immediately.**
7. **Tighten the blade installation bolts securely.**
8. **Remove nails and clean the workpiece before cutting. Nail, sand or foreign matter can cause blade damage.**
9. **Do not remove chips from the chip chute when the motor is running. Clean out chips after the blades come to a complete stop. Always use a stick etc. when cleaning them out.**
10. **Do not leave the tool running.**
11. **Do not abuse cord. Never yank cord to disconnect it from the receptacle. Keep cord away from heat, oil, water and sharp edges.**
12. **The tool should only be used for wood and similar materials.**

**SAVE THESE INSTRUCTIONS.**

### **⚠WARNING:**

**DO NOT let comfort or familiarity with product (gained from repeated use) replace strict adherence to safety rules for the subject product.**

**MISUSE or failure to follow the safety rules stated in this instruction manual may cause serious personal injury.**

## INSTALLATION

### Movement and transport of thicknesser

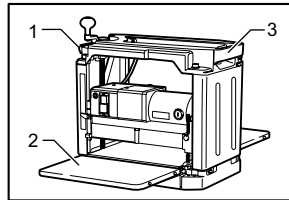

1. Carrying handle
2. Sub-table
3. Carrying handle

004462

### **⚠CAUTION:**

- Watch your step when moving the tool. Fold the sub-tables. Grasp the carrying handles when moving the tool.
- When transporting it by vehicle, secure with a rope or other substantial means to prevent tipping or movement.

### Positioning the thicknesser

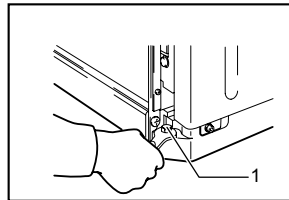

1. Bolt or screw

003708

Locate the tool in a well lit and level place where you can maintain good footing and balance. Bolt/screw it to the workbench or stand (optional accessory) using the bolt holes provided in the base.

## FUNCTIONAL DESCRIPTION

### **⚠CAUTION:**

- Always be sure that the tool is switched off and unplugged before adjusting or checking function on the tool.

## Switch action

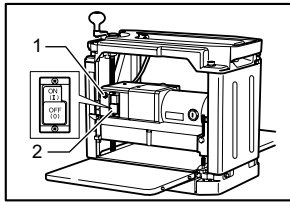

004463

1. Pilot lamp
2. Switch

### ⚠CAUTION:

- Before plugging in the tool, always be sure that the tool is switched off. The pilot lamp lights up when the tool is plugged into the power source.

To start the tool, press the ON ( 1 ) button. To stop it, press the OFF ( O ) button.

## Dimensional adjustment

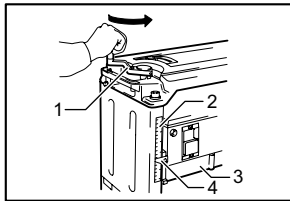

004464

1. Crank handle
2. Scale
3. Main frame
4. Indicator plate

Lower the main frame by turning the crank handle counterclockwise until the indicator plate points to the scale graduation indicating the desired finished dimension. One full turn of the crank handle moves the main frame 2 mm up or down. The scale has inch graduations on its right side and metric graduations on its left side.

### Adjusting depth of cut

The maximum depth of cut differs depending upon the width of workpiece being cut. Refer to the table. When you need to remove more than the amount specified in the table, set the depth of cut shallower than the amount and make two or more passes.

Width of workpiece being cut	Maximum depth of cut
Less than 150 mm	3.0 mm
150 mm - 240 mm	1.5 mm
240 mm - 304 mm	1.0 mm

004465

To adjust the depth of cut, proceed as follows.

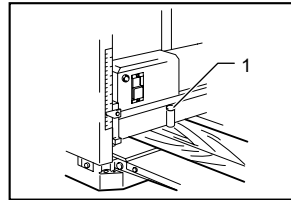

004466

1. Depth gauge

Insert the workpiece flat on the table top. Lower the main frame by turning the crank handle counterclockwise. The depth gauge will rise and the amount of gauge rise indicates the depth of cut.

### ⚠CAUTION:

- Always lower the main frame when aligning the indicator plate with the graduation indicating the desired finished dimension. If you raise the main frame into the desired finished dimension, additional play in the screw may result. This may cause an undesired finished dimension.
- Always place the workpiece flat on the table top when predetermining the depth of cut. Otherwise, the predetermined depth of cut will differ from actual depth of cut.

## Depth adjusting gauge

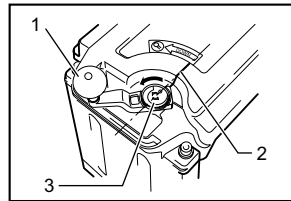

003713

1. Crank handle
2. Groove
3. Depth adjusting gauge

Use the depth adjusting gauge when you need to predetermine the depth of cut more accurately. To do so, proceed as follows.

1. First, plane the workpiece at the predetermined depth of cut. Measure the thickness of the planed piece to know how much more stock you need to remove.
2. Turn the depth adjusting gauge on the crank handle until the 0 graduation is aligned with the groove on the tool.
3. Now turn the crank handle counterclockwise until the graduation for the desired depth of cut is aligned with the groove on the tool.
4. When you need to remove more than the amount specified in the table mentioned in the "Adjusting depth of cut" section, set the depth of cut shallower than the amount and make two or more passes.

## Stopper

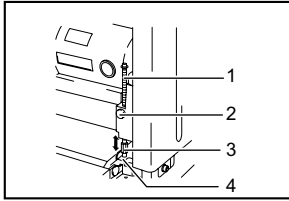

1. Stopper
2. Stopper button
3. Stopper knob
4. Table top

003714

Use the stopper when you need to plane many workpieces to the same thickness. To do so, proceed as follows.

1. Turn the crank handle until the indicator plate points to the scale graduation indicating the desired finished dimension.
2. Depress the stopper button and lower the stopper until it just contacts the table top.
3. If you need fine adjustment of the stopper, turn the stopper knob.

### ⚠ CAUTION:

- When the stopper is not in use, always raise it to the topmost position. Never force the crank handle when the stopper is in contact with the table top. This may cause tool damage.

## ASSEMBLY

### ⚠ CAUTION:

- Always be sure that the tool is switched off and unplugged before carrying out any work on the tool.

### Replacing blades

### ⚠ CAUTION:

- Handle the blades very carefully when removing or installing the blades to prevent cuts or injury from the blades and to prevent damage to the blades. They are razor-sharp.
- Clean out all chips, dust, pitch or foreign matter adhering to the drum or blades before installing the blades.
- Use blades of the same dimensions and weight , or drum oscillation/vibration will result, causing poor cutting action and eventually, tool breakdown.
- Replace both blades at the same time.
- The disposable-type blade has a cutting edge on both sides. When one cutting edge becomes dull, you can use the other cutting edge. Always remove resin and dirt sticking to the reverse side of the blade before using the other cutting edge. This blade must not be re-sharpened. When both cutting edges become dull, the blade should be carefully

thrown away.

### 1. Removing blades

Loosen the thumb screw which secures the chip cover and remove the chip cover. Remove the screws which secure the right side cover. Then remove the right side cover. Turn the pulley until the drum can be locked in the position whereby the blade installation bolts face upward.

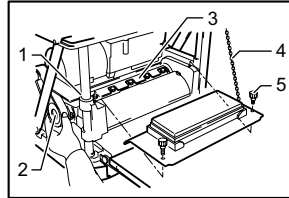

004467

1. Lock plate
2. Pulley
3. Drum
4. Chain
5. Thumb screw

### For throw away blades only

Place the two magnetic holders on the set plate and push them in the direction of the arrow until the claw contact the blade. Remove the six blade installation bolts using the socket wrench. Grip the magnetic holders and raise them straight up to remove the set plate and the blade from the drum. Press the lock plate and turn the pulley 180° to lock the drum. Remove the other blade as described above.

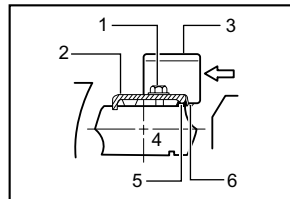

003716

1. Blade installation bolts
2. Set plate
3. Magnetic holder
4. Drum
5. Blade
6. Claw

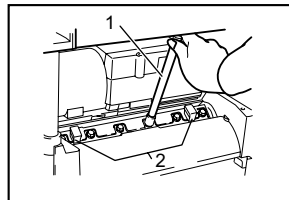

003717

1. Socket wrench
2. Magnetic holders

### For standard blades only

Remove the six installation bolts using the socket wrench. Raise the set plate and blade straight up to remove them from the drum. Press the lock plate and rotate the drum by turning the pulley 180° to lock the drum. Remove the other blade as described above. Remove the set plate from the blade.

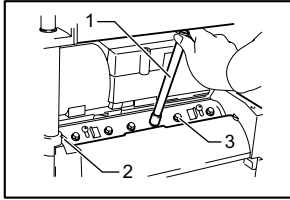

1. Socket wrench
2. Lock plate
3. Blade installation bolt

004468

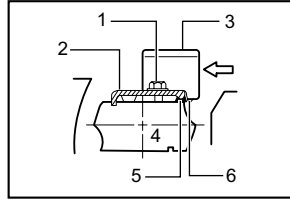

1. Blade installation bolts
2. Set plate
3. Magnetic holder
4. Drum
5. Blade
6. Claw

003716

After tightening all the blade installation bolts lightly and evenly from the center to the outside, tighten them completely following the same sequence. Remove the magnetic holders from the set plate.

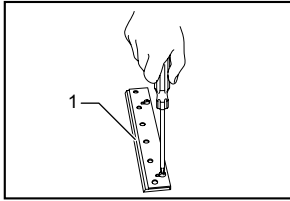

1. Set plate

004469

## 1. Installing blades

### ⚠CAUTION:

- Use only Makita socket wrench provided to tighten the blade installation bolts. The use of any other socket wrench may cause overtightening or insufficient tightening of the bolts, resulting in severe injury.

### For throw away blades only

Provide a flat wood block approximately 300 mm long and 100 mm wide. Place the blade and the set plate on the wood block so that the blade locating lug of the set plate rests in the groove of the blade. Adjust the set plate so that both ends of the blade protrude approximately 1 mm beyond the end of the set plate. Place the two magnetic holders on the set plate and push them until the claw contacts the blade.

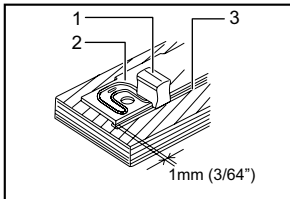

1. Magnetic holder
2. Set plate
3. Blade

003718

Grip the magnetic holder and slip the heel of the set plate into the groove in the drum. Install the blade installation bolts.

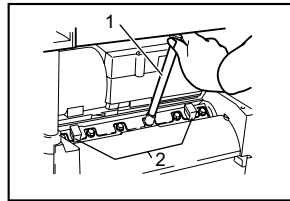

1. Socket wrench
2. Magnetic holders

003717

Install the other blade as described above. Rotate the drum slowly while pressing the lock plate to make sure there is nothing abnormal. Then install the chip cover and the side cover.

### ⚠CAUTION:

- Do not tighten the blade installation bolts without the blade locating lug of the set plate correctly resting in the groove of the blade. This may cause damage to the blade and potential injury to the operator.
- Do not turn the tool on with the chip cover removed.
- When installing the chip cover, make sure that the chain is not caught by the chip cover.

### For standard blades only

Place the blade on the blade gauge so that the blade edge is perfectly flush with the inside of the front rib (A). Place the set plate on the blade, then gently press the heel of the set plate flush with the back side of the blade gauge (B). Tighten the screws to secure the set plate to the blade.

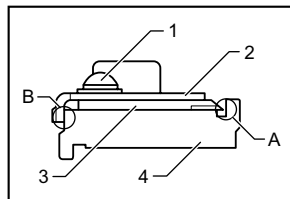

1. Screw
2. Set plate
3. Blade
4. Blade gauge

004470

Slip the heel of the set plate into the groove in the drum.  
Install the blade installation bolts.

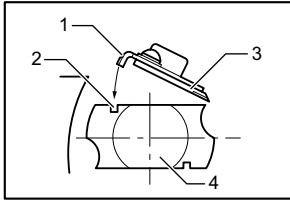

004471

1. Set plate
2. Groove
3. Blade
4. Drum

After tightening all the blade installation bolts tightly and evenly from the center to the outside, tighten them completely following the same sequence.

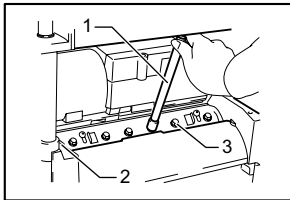

004472

1. Socket wrench
2. Lock plate
3. Blade installation bolt

Install the other blade as described as above. Rotate the drum slowly while pressing the lock plate to make sure there is nothing abnormal. Then install the chip cover and the side cover.

#### ⚠CAUTION:

- Tighten the blade installation bolts securely when installing the blades.
- Do not turn the tool on with the chip cover open.
- When installing the chip cover, make sure that the chain is not caught by the chip cover.

#### Changing type of blade

This tool can accept either throw away blades or standard blades. If you wish to change the type of blade, buy and use the following parts.

Changing from standard blade to throw-away blade	Changing from throw-away blade to standard blade
Set plate ----- 2 pcs.	Set plate ----- 2 pcs.
Throw-away blade (306 mm) --- 2 pcs.	Pan head screw M 4 x 6 ---- 4 pcs.
Magnetic holder ----- 2 pcs.	Standard blade ----- 2 pcs.
	Blade gauge -----1 pc.

006417

#### Hood set

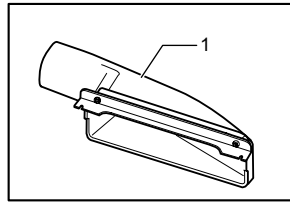

004473

1. Hood set

When you wish to maintain clean operations through easy dust collection, connect the vacuum cleaner to the thicknesser using this hood.

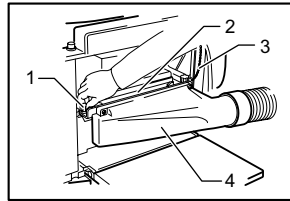

004474

1. Thumb screw
2. Chip cover
3. Chain
4. Hood set

Loosen the thumb screws which secure the chip cover. Attach the hood to the thicknesser and secure the chip cover and the hood together by tightening the thumb screws.

#### ⚠CAUTION:

- When installing the hood set, make sure that the chain is not caught by the chip cover or hood set.

## OPERATION

#### ⚠CAUTION:

- Two or more pieces of narrow but similar thickness stock can be passed through the thicknesser side by side. However, allow some spacing between the stock to permit the feed rollers to grip the thinnest piece of stock. Otherwise, a slightly thinner piece could be kicked back by the cutterhead.

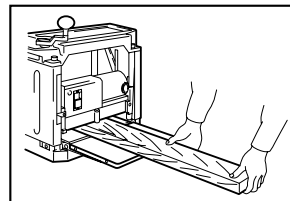

004475

Place the workpiece flat on the table top.  
Determine the depth of cut as described before.



Switch on the tool and wait until the blades attain full speed. The workpiece should not be in contact with the feed roller when you turn the tool on.

Then insert the workpiece flush with the table top.

When cutting a long or heavy workpiece, lift up its end slightly at the start and the end of the cut to avoid gouging or snipping at the extreme ends of the workpiece.

The use of the tool top enables quick, effortless return of the workpiece to the infeed table side. This is especially convenient with two operators.

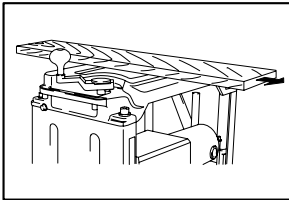

003725

**CAUTION:**

- The workpiece with the following dimensions cannot be fed into the tool because the interval between two feed rollers is 129 mm. Do not try to cut them.

1	 Less than 130mm	Less than 130 mm long
2	 More than 130mm	Having a groove more than 130mm wide
3	 130mm	Having grooves at intervals of 130 mm wide

004476

**CAUTION:**

- Stop the tool when the workpiece has stalled. Allowing the tool to run with a stalled workpiece causes rapid wearing of the feed rollers.

## MAINTENANCE

**CAUTION:**

- Always be sure that the tool is switched off and unplugged before attempting to perform inspection or maintenance.
- Never use gasoline, benzine, thinner, alcohol or the like. Discoloration, deformation or cracks may result.

### Adjusting height of sub-table

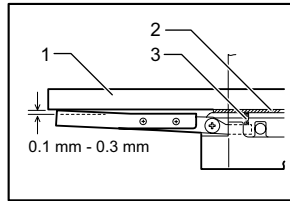

004477

- Ruler
- Post card
- Adjusting screw

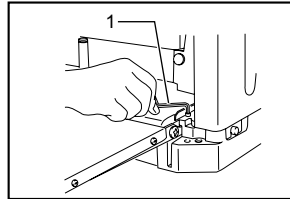

003728

- Hex wrench

The height of sub-table is factory-adjusted. If further adjustment is necessary, proceed as follows.

Place a postcard on the table and also place a ruler on the postcard. Turn the adjusting screw with the hex wrench until the end of the sub-table contacts the ruler. Now the end of the sub-table is from 0.1 mm to 0.3 mm above the table surface.

### Replacing carbon brushes

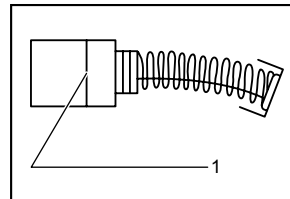

001145

- Limit mark

Remove and check the carbon brushes regularly. Replace when they wear down to the limit mark. Keep the carbon brushes clean and free to slip in the holders. Both carbon brushes should be replaced at the same time. Use only identical carbon brushes.

Use a screwdriver to remove the brush holder caps. Take out the worn carbon brushes, insert the new ones and secure the brush holder caps.

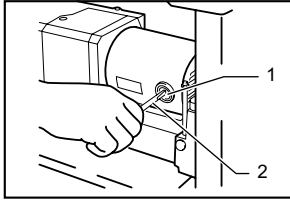

1. Brush holder cap
2. Screwdriver

003729

### Keeping blades sharp

Dull blades can cause rough finish, an overload of the motor and dangerous kickback of the workpiece. Replace dull blades immediately.

### Lubrication

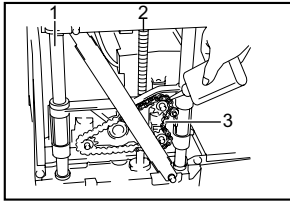

1. Column
2. Screw
3. Chain

003730

Oil the chain (after removing the side cover R), the four columns and the screws for elevating the main frame. This periodic lubrication should be performed with machine oil.

### CAUTION:

- Oiling and all maintenance should be done with the tool turned off and unplugged.

### Cleaning

Always brush off dirt, chips and foreign matter adhering to the roller surfaces, motor vents and drums.

### Limit for re-sharpening of standard blade

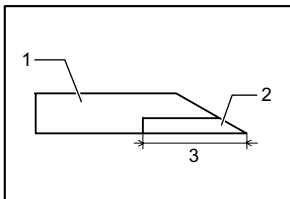

1. Base
2. Blade
3. More than 4 mm

004478

Do not use the standard blade whose blade length is under 4 mm.

To maintain product SAFETY and RELIABILITY, repairs, any other maintenance or adjustment should be performed by Makita Authorized Service Centers, always using Makita replacement parts.

## ACCESSORIES

### CAUTION:

- These accessories or attachments are recommended for use with your Makita tool specified in this manual. The use of any other accessories or attachments might present a risk of injury to persons. Only use accessory or attachment for its stated purpose.

If you need any assistance for more details regarding these accessories, ask your local Makita Service Center.

- Magnetic holder
- Throw-away blade
- Standard blade
- Blade gauge
- Socket wrench 9
- Hex wrench 2.5
- Hood set
- Stand

---

---

---

---

---

---

---

---

---

---

---

---

---

---

---

---

---

---

---

---

---

---

---

**Makita Corporation**  
Anjo, Aichi, Japan

884278C227

[www.makita.com](http://www.makita.com)